



WINE COLLECTION



PERLICK'S INDUSTRY-LEADING
COLUMN AND UNDERCOUNTER
WINE RESERVES



(Left to right) 24" Column Wine Reserve, 24" Signature Series Beverage Center, 24" Signature Series Refrigerator with Martini Rack, 24" Column Wine Reserve

THE PERLICK **WINE** COLLECTION

There is a reason it's called a wine collection. Each bottle is carefully curated - specially chosen for its flavor profile, a special memory, or as a reminder of that incredible trip to Napa. No two wine collections are the same, just like all wine refrigerators are not created equal.

You can enjoy the same commercial-grade performance that the fine dining restaurants Perlick serves demand - in the comfort of your own home. Combined with the high end design you desire, a Perlick Wine Reserve offers unparalleled preservation and presentation.





COMBATING THE ENEMIES OF

WINE

PERLICK COLUMN AND UNDERCOUNTER
WINE RESERVES FOR THE HOME

Wine is complex. Whether it is a crisp white or a robust red, all wine is perishable and requires proper conditions to protect it from spoilage. Perlick wine reserves are designed to combat the common enemies of wine so that you can enjoy it at its peak.



THE ENEMY Temperature

Temperature swings can be detrimental to wine. Exposure to heat can cause wine to push the cork out of the bottle, while extreme cold paralyzes wine and ruins its natural development and taste.

THE SOLUTION High-Performance Refrigeration

Perlick's proprietary RAPIDcool forced-air refrigeration system circulates cold air throughout the cabinet, providing industry-leading temperature uniformity within 1° of setpoint.



THE ENEMY Vibration And Oxygen

Wine continues to develop long after you bring it home. Frequent disturbances, such as vibration, agitate wine and interrupt the maturation process. Bottles must also remain sealed to keep oxygen out.

THE SOLUTION Unparalleled Construction

Foamed-in-place stainless steel walls provide a solid foundation for the reserve, while soft coat, full extension shelves gently cradle each bottle. Wine is stored horizontally to keep corks from drying out and letting oxygen seep in.



ENEMY Light

Exposure to light will prematurely age and potentially damage wine. Ultraviolet light causes wine to become cloudy and give off strong odors, negatively affecting the wine's flavor.

THE SOLUTION Premium Glass

Perlick specifies the highest quality glass specially manufactured to protect interiors and increase overall strength. Multi-pane Low-E glass is coated with UV-resistant protection to limit the amount of ultraviolet light entering the reserve.



ENEMY Odor

Strong odors - especially musty or moldy odors and dry rot - can affect the flavor of wine. It is highly recommended that wine is stored in an odorless, non-aromatic environment.

THE SOLUTION Stainless Steel

All Perlick column and undercounter wine reserves feature Perlick's signature stainless steel interiors. Stainless steel is sanitary and resists odors and stains, unlike plastic and wood.

MEET THE PERLICK WINE COLUMN COLLECTION

Because nothing protects, preserves, and presents a treasured wine collection like a Perlick.

- Wine columns are available in an industry exclusive single-zone temperature model for maximum capacity or a dual-zone model to store red and white wine at their recommended temperatures.
- Wine columns feature a convertible display shelf to showcase 6 prized wine bottles with additional storage for 4 dessert (half sizes) wine bottles when angled up. The shelf easily lays flat to store 11 bottles without additional parts and pieces.
- Perlick's advanced technology monitors humidity levels in our wine reserve and, if necessary, pushes additional moisture into the compartment to maintain 60-70% relative humidity. This preserves corks and prevents oxidation. Soft coat, full extension shelves gently cradle each bottle and protect them from vibration.
- All columns have stainless steel interiors and exteriors for long life durability, easy cleaning, and sanitation. Manufactured ready to accept custom or stainless steel panels.
- Vibrant blue or white LED roll-on theatre lighting adjusts for display or storage, and emits no UV light to protect against oxidation and degradation.



Convertible display shelf



PerliQ™ Touch Screen Control Panel
(all columns)

AVAILABLE MODELS

24" COLUMN DUAL-ZONE WINE RESERVE - 86 bottle capacity - 46 in top zone, 40 in bottom zone

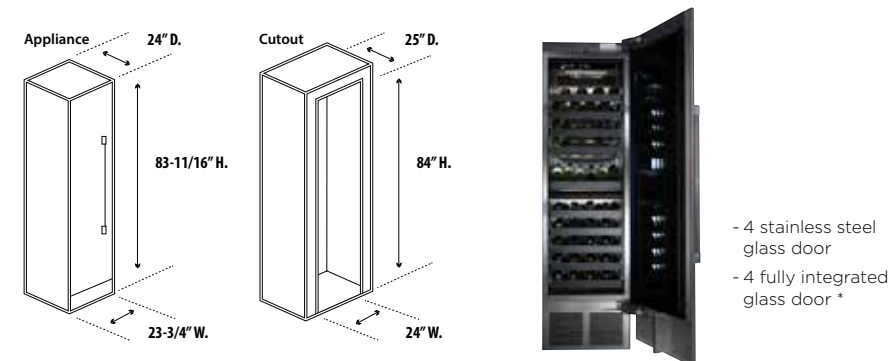

24" COLUMN SINGLE-ZONE WINE RESERVE - 94 bottle capacity

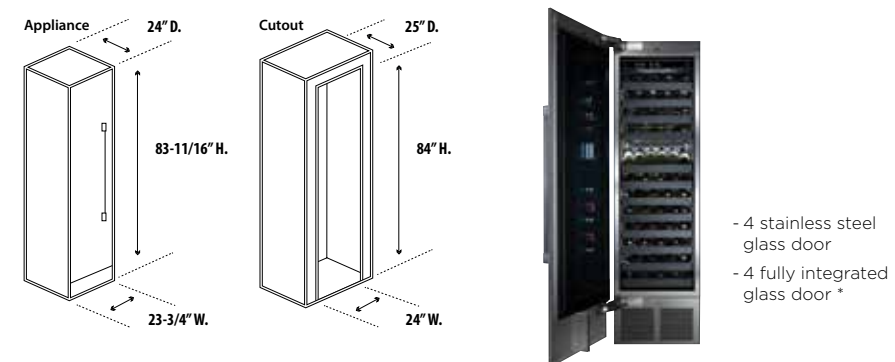

* This model comes ready to accept a custom panel

MEET THE SIGNATURE SERIES

Part of our flagship collection, Perlick Signature Series Wine Reserves come in a variety of sizes and styles to fit any space and storage need. They're the crème de la crème of undercounter refrigeration, and every Signature Series model is available for indoor or outdoor use as well as Marine Grade.

- Available in 15" and 24" models, as well as the exclusive Signature Series Shallow Depth models which feature an 18" depth
- Robust 1000 BTU refrigeration system powered by Perlick's exclusive variable speed compressor provides industry-leading cooling capabilities and intuitive temperature control, which means system will only run when it senses a temperature rise
- Front vented, RAPIDcool™ forced air refrigeration system provides the most energy efficient cool down, up to 70% faster than leading competitors
- State-of-the-art digital temperature control with audible door alarm in all models
- Illuminated by dual-color LED lighting, giving you the option of 6000K Crisp White or Cool Blue lighting with just the press of a button
- Stainless steel interiors and exteriors for long life durability and easy cleaning
- All Signature Series products are available as indoor or UL-rated outdoor models
- Industry-exclusive Shallow Depth undercounter refrigeration that measures just 18" deep
- Measuring 32" tall, the Shallow Depth collection is ADA height compliant for accessible and aging-in-place needs



AVAILABLE MODELS

 **OUTDOOR
MODELS AVAILABLE**

15" SIGNATURE SERIES WINE RESERVES – 20 bottle capacity

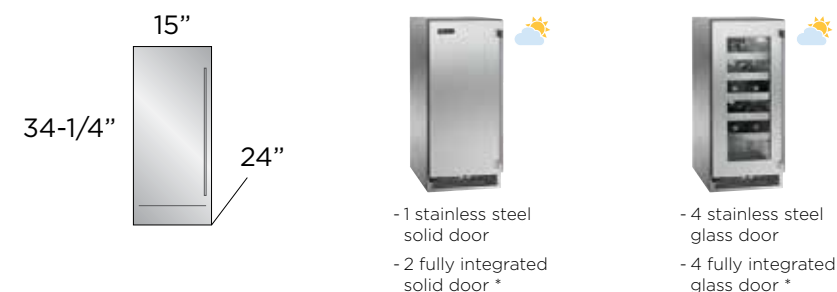

24" SIGNATURE SERIES WINE RESERVES (Single-Zone Models) – 40 bottle capacity



24" SIGNATURE SERIES WINE RESERVES (Dual-Zone Models) – 32 Bottle capacity - 18 in top zone (red), 14 in bottom zone (white)



SIGNATURE SERIES SHALLOW DEPTH WINE RESERVES (ADA-height compliant) – 20 bottle capacity



* This model comes ready to accept a custom panel

MEET THE C-SERIES & ADA HEIGHT COMPLIANT SERIES

Perlick's C-Series and ADA Height Compliant Series Wine Reserves are inspired by the commercial wine refrigeration we produce for the finest bars and restaurants across North America. These wine reserves combine commercial durability and craftsmanship without sacrificing aesthetics and performance – all at an affordable price point.

AVAILABLE MODELS

24" C-SERIES WINE RESERVES - 40 bottle capacity

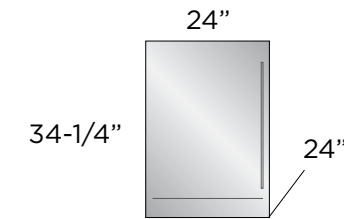

- 1 stainless steel solid door
- 2 fully integrated solid door *



- 4 stainless steel glass door
- 4 fully integrated glass door *

24" ADA HEIGHT COMPLIANT SERIES WINE RESERVES - 40 bottle capacity

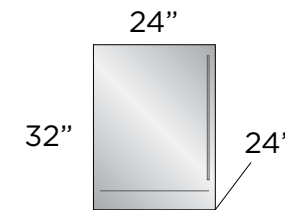

- 1 stainless steel solid door
- 2 fully integrated solid door *



- 4 stainless steel glass door
- 4 fully integrated glass door *

- Robust 800 BTU refrigeration system featuring Perlick's exclusive front vented, RAPIDcool™ forced-air refrigeration system
- Rated for beverage and open food storage
- Digital temperature control with audible door alarm in all models
- Stainless steel interiors
- Full extension smooth glide shelving eliminates reaching into the back of the cabinet
- Industry's Best 6 Year Full Parts and Labor Warranty
- ADA Series units feature 32" height and ADA height compliant product design for accessible and aging-in-place designs











* This model comes ready to accept a custom panel

WINE PAIRINGS

WINE COLOR AND DESCRIPTION

SERVING TEMPS

PAIRS WELL WITH ...

	CABERNET SAUVIGNON Known to be dry in style with complex dark fruit and spice notes	61°- 64°F (16°- 18°C)	Gorgonzola, beef, duck, walnuts, dark chocolate
	CHARDONNAY Medium to medium-dry in style with citrus and pear notes. When aged in oak, it becomes buttery with vanilla and oak notes	48°- 52°F (9°- 11°C)	Mild cheeses, hummus, scallops and other light seafood dishes
	MERLOT A complex blend of fresh red fruits (currants, plums, cherries) with a hint of cedar when aged in oak	61°- 64°F (15°- 17°C)	Antipasto, veal, aged cheeses, eggplant, dark berry desserts
	PINOT GRIGIO Dry light to medium bodied with crisp fruit flavors such as pear or lemon	44°- 47°F (7°- 8°C)	Ceviche, quiche, crab, lobster, risotto, apple tart
	PINOT NOIR Velvet and complex, filled with the flavors of red fruit, spice, and chocolate. When aged in oak, it takes on cedar notes	50°- 55°F (10°- 13°C)	Creamy cheeses, roasted vegetables, game dishes, berry tart, crème brûlée
	RIESLING A sweet German wine that boasts bright floral and fruit notes with a touch of honey	43°- 46°F 6°- 8°F	Light seafood, roasted chicken, grilled pork, light cakes and cream-based pies
	SAUVIGNON BLANC Dry white wine that features distinct melon, fig, citrus, and herb flavors	45°- 50°F 7°-10°C	Shellfish, goat cheese, chicken, grilled vegetables, sorbet
	SYRAH/SHIRAZ A rich, spicy red wine with distinct dark berry, pepper, and coffee notes	63°- 65°F 17°-18°C	Bruschetta, tamenade, red meat, barbeque, chocolate mousse

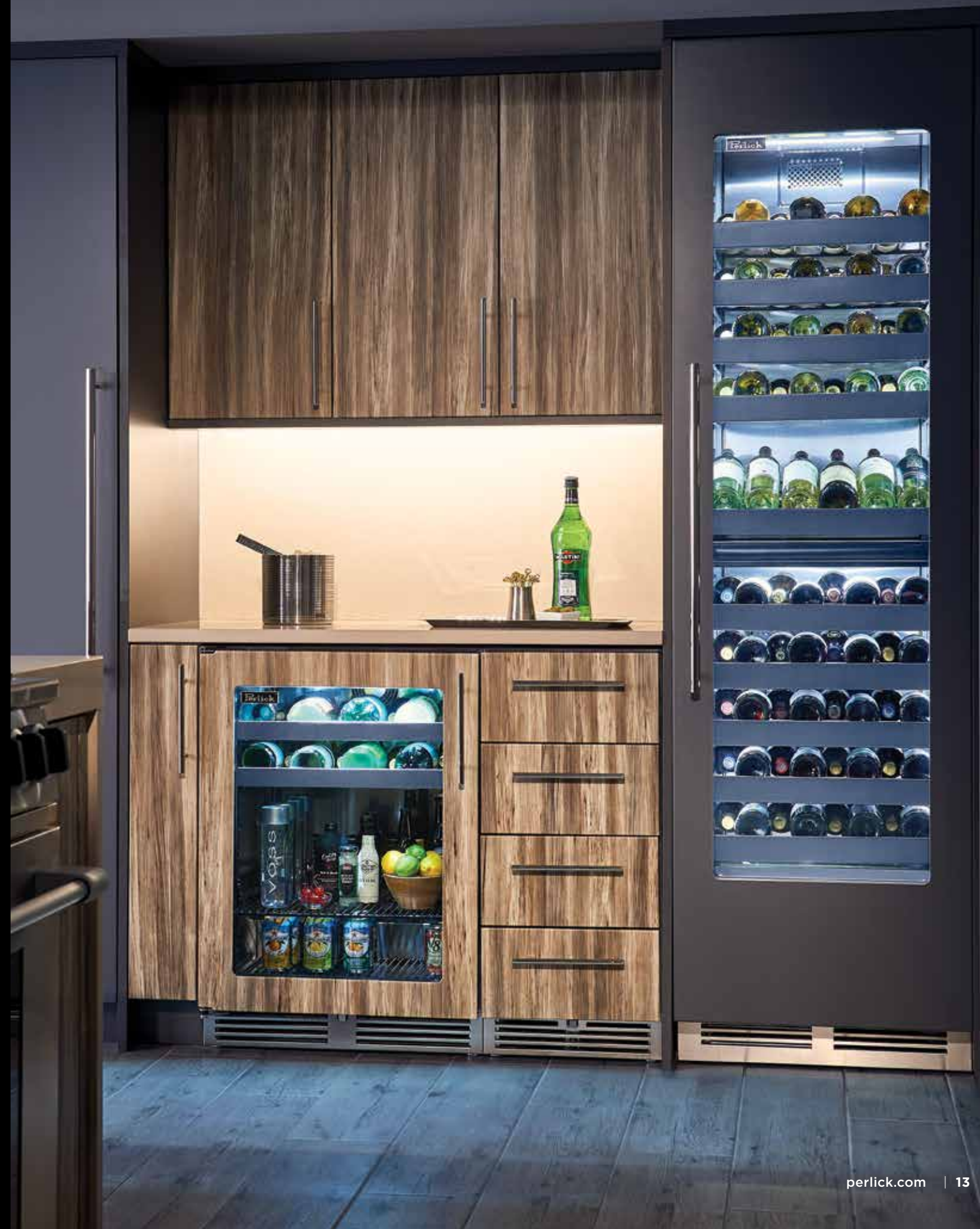

MODEL SPECIFICATION GUIDE

Model	Type	Page	Description	Overall Dimensions - in. (mm) / Cutout Dimensions - in. (mm)			Shelving (Door Models)	Capacity	Storage Capacity
				Width	Depth	Height			
CR24W-1-2*	24" Wine Reserve	6	Single-Zone Wine Reserve, hinge reversible	23-3/4" (603)	24" (610)	83-11/16" (2126)	12 full extension wine shelves including one convertible display shelf	12.6 cu.ft.	94 750 mL bottles (99 Bottles if you double stack the display shelf)
				24" (610)	24" (610)	84" (2134)			
CR24D-1-2*	24" Wine Reserve	6	Dual-Zone Wine Reserve, hinge reversible	23-3/4" (603)	24" (610)	83-11/16" (2126)	10 full extension wine shelves including one convertible display shelf	12.2 cu.ft.	86 750 mL bottles (91 Bottles if you double stack the display shelf)
				24" (610)	24" (610)	84" (2134)			

Model	Type	Page	Description	Overall Dimensions - in. (mm) / Cutout Dimensions - in. (mm)			Shelving (Door Models)	Capacity	Storage Capacity
				Width	Depth	Height			
HP24CS-4-**	Refrigerator/Wine Reserve	8	24" Signature Series Indoor Dual-Zone Refrigerator/Wine Reserve	23-7/8" (606)	24" (610)	34-1/4" (870)	2 full extension wine shelves, 1 full extension shelf	5.0 cu.ft.	41 cans and 14 bottles of wine
				24" (610)	24" (610)	34-1/2" (876)			
HP15WS-4-**	Wine Reserve	8	15" Signature Series Indoor Wine Reserve	14-7/8" (378)	24" (610)	34-1/4" (870)	5 full extension wine shelves	2.8 cu.ft.	20 bottles of wine
				15" (381)	24-7/8" (632)	34-1/2" (876)			
HP24WS-4-**	Wine Reserve	8	24" Signature Series Indoor Single-Zone Wine Reserve	23-7/8" (606)	24" (610)	34-1/4" (870)	5 full extension wine shelves	5.2 cu.ft.	45 bottles of wine
				24" (610)	24" (610)	34-1/2" (876)			
HP24DS-4-**	Wine Reserve	8	24" Signature Series Indoor Dual-Zone Wine Reserve	23-7/8" (606)	24" (610)	34-1/4" (870)	2 (Upper) + 2-1/2 (Lower) full extension wine shelves	5.2 cu.ft.	32 bottles of wine
				24" (610)	24" (610)	34-1/2" (876)			
HH24WS-4-**	Wine Reserve	8	18" Signature Series Indoor Shallow Depth Wine Reserve (ADA height compliant)	23-7/8" (606)	18" (457)	32" (813)	4 full extension wine shelves	3.1 cu.ft.	20 bottles of wine
				24" (610)	18" (457)	32-1/4" (819)			

Model	Type	Page	Description	Overall Dimensions - in. (mm) / Cutout Dimensions - in. (mm)			Shelving (Door Models)	Capacity	Storage Capacity
				Width	Depth	Height			
HC24WB-4-**	Wine Reserve	10	24" C-Series Indoor Wine Reserve	23-7/8" (606)	24" (610)	34-1/4" (870)	5 full extension wine shelves	5.2 cu.ft.	45 bottles of wine
				24" (610)	24" (610)	34-1/2" (876)			
HA24WB-4-**	Wine Reserve	10	ADA Height Compliant Indoor Wine Reserve	23-7/8" (606)	24" (610)	32" (813)	4 full extension wine shelves	4.8 cu.ft.	32 bottles of wine
				24" (610)	24-7/8" (632)	32-1/4" (819)			

Temp. Range °F(°C)	Power Requirements	Refrigerant	LED Lighting Options	K Level	Door Styles	Outdoor Model Number	Warranty	Industry Exclusive
40°(4.4°) - 68°(20°)	115 VAC/60 Hz/2.3 Amps	R600a (50g)	White and blue roll-on theater lighting including Sabbath Mode	4000K	1,2,3,4	N/A	Full 6 Year	
Upper zone - 40°(4.4°) - 68°(20°) Lower zone - 40°(4.4°) - 68°(20°)"	115 VAC/60 Hz/2.3 Amps	R600a (50g)	White and blue roll-on theater lighting including Sabbath Mode	4000K	1,2,3,4	N/A	Full 6 Year	

Temp. Range °F(°C)	Power Requirements	Refrigerant	LED Lighting Options	K Level	Door Styles	Outdoor Model Number	Marine Model Number	Warranty	Industry Exclusive
Lower (33° - 42°F) / Upper (45° - 65°F)	115 VAC/60 Hz/1 Ph	R600a (57g)	Cool blue or crisp white	6000K	1,2,3,4	HP24CO-4-**	HP24CM-4-**	Full 6 Year	●
45° (7.2°) - 65° (18.33°)	115 VAC/60 Hz/1 Ph	R600a (38g)	Cool blue or crisp white	6000K	1,2,3,4	HP15WO-4-**	HP15WM-4-**	Full 6 Year	
45° (7.2°) - 65° (18.3°)	115 VAC/60 Hz/1 Ph	R600a (50g)	Cool blue or crisp white	6000K	1,2,3,4	HP24WO-4-**	HP24WM-4-**	Full 6 Year	
45° / 51° (7.2° / 10.5°) - 55° / 65° (12.7° / 18.3°)	115 VAC/60 Hz/1 Ph	R600a (45g)	Cool blue or crisp white	6000K	1,2,3,4	HP24DO-4-**	HP24DM-4-**	Full 6 Year	
45° (7.2°) - 65° (18.3°)	115 VAC/60 Hz/1 Ph	R600a (50g)	Cool blue or crisp white	6000K	1,2,3,4	HH24WO-4-**	HH24WM-4-**	Full 6 Year	●

Temp. Range °F(°C)	Power Requirements	Refrigerant	LED Lighting Options	K Level	Door Styles	Outdoor Model Number	Warranty	Industry Exclusive
45° (7.2°) - 65° (18.3°)	115 VAC/60 Hz/1 Ph	R600a (50g)	Cool blue or crisp white	6000K	1,2,3,4	N/A	Full 6 Year	
45° (7.2°) - 65° (18.3°)	115 VAC/60 Hz/1 Ph	R600a (50g)	Cool blue or crisp white	6000K	1,2,3,4	N/A	Full 6 Year	

DOOR STYLE GUIDE: 1) Stainless Steel Solid Door 2) Fully Integrated Solid Door 3) Stainless Steel Glass Door 4) Fully Integrated Glass Door 5) Stainless Steel Drawers 6) Fully Integrated Drawers

ROUGH CUTOUT DIMENSIONS

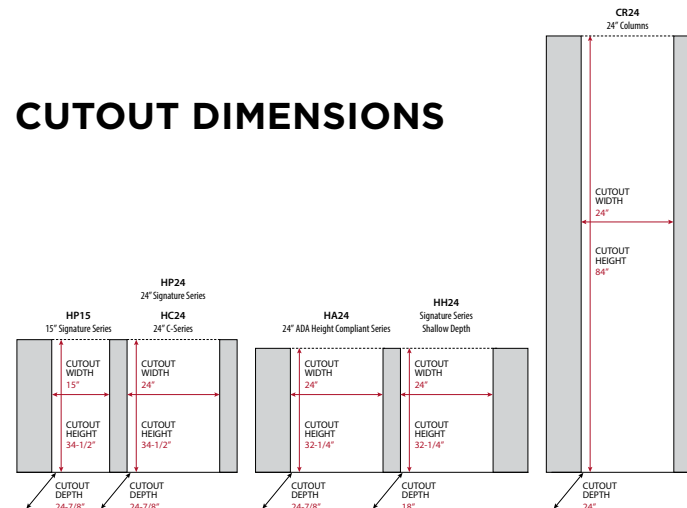

* For all HP, HC, and HA models. To achieve 24" installation depth, install electrical connection in adjacent cabinetry. See spec sheets and installation instructions for install instructions.

* HH24 models have a recessed plug for a true 18" depth.

SHELVING AND COMPARTMENT ACCESSORIES

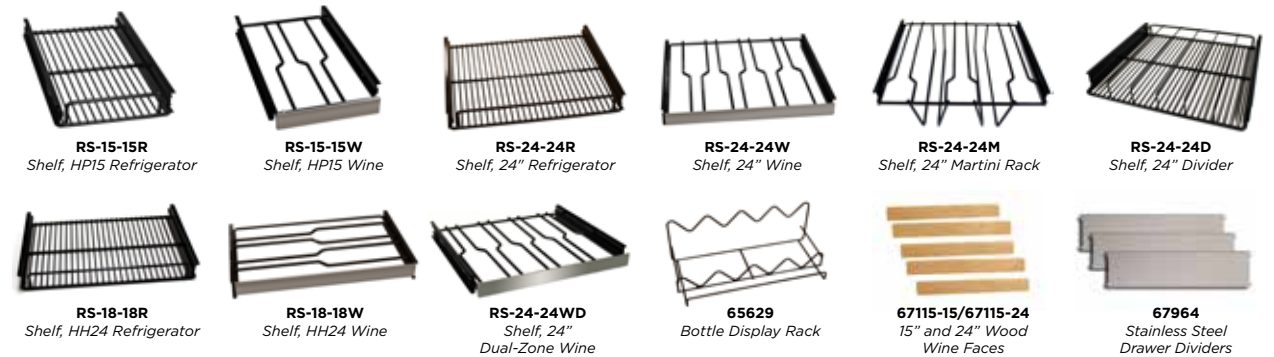



8300 West Good Hope Road
Milwaukee, WI 53223
phone **800.558.5592**
web **perlick.com**

